

Aurelia Bold S 22

Patrick Jouin, 2021



Description

Collection of hand-blown glass pendants in transparent or smoke grey combined with a metal structure in hand finished vintage brass, matte gunmetal or glossy warm white. Two shapes/dimensions and six color combinations with matching canopy. Two integrated LED light sources (direct and indirect) with the ability to turn on/off/dim independently. Both LEDs are available in 2700K or 3000K and are user replaceable. Smart disassembly system to remove the glass diffuser for quick and easy cleaning.

Product features

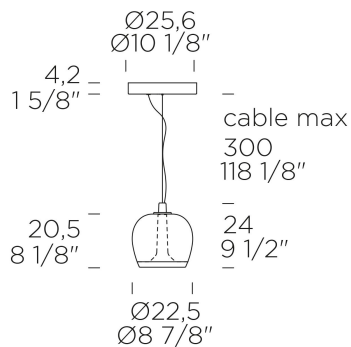

Product code

0011499

Structure finish

Pendant

Environment

Indoor

Materials

glass, metal

Finitura diffusore
smoke grey

Certifications
CE 

Finitura struttura
matte gunmetal

Protection degree
IP 20

Dimensions
118in x 9in x 8in

Net weight
4kg

Gross weight
5,6kg

Light source

Standard

DIRECT LIGHT: LED 1 x 11,6W 1531 lm 3000K CRI?90 + INDIRECT LIGHT: LED 1 x 7,2W 784 lm 3000K CRI?90 (dimnable: Push-dim; 0/1-10V. On request: phase cut dimmer and DALI).

Product available also on these versions

source DIRECT LIGHT: LED 1 x 11,6W 1531 lm 3000K CRI?90 + INDIRECT LIGHT: LED 1 x 7,2W 784 lm 3000K CRI?90 (dimnable: Push-dim; 0/1-10V. On request: phase cut dimmer and DALI). A++/A

structure finish

 glossy warm white

 vintage brass

 glossy warm white

 matte gunmetal

 vintage brass

diffuser finish

 smoke grey

 smoke grey

 transparent

 transparent

 transparent

code

0011501

0011497

0011495

0011493

0011491

Models



Aurelia S 45

Pendant



Aurelia Bold S 22

Pendant